

use & care guide

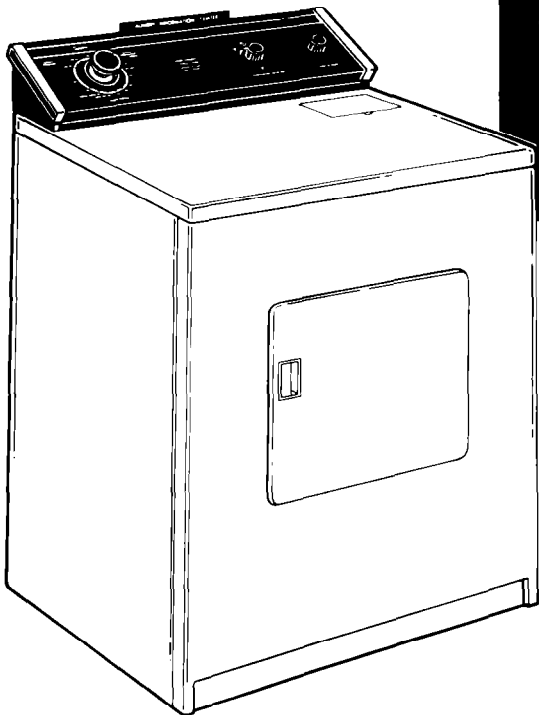

AUTOMATIC DRYERS

**Electric Model
LE5790XS
and
Gas Model
LG5791XS**

Microwave Ovens, Trash Compactors, Room Air Conditioners, Dehumidifiers, Automatic Washers, Clothes Dryers, Freezers, Refrigerator-Freezers

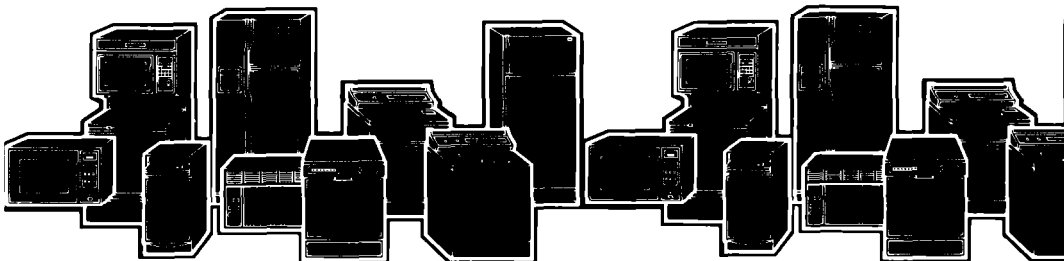

Parts and features

CYCLE CONTROL KNOB

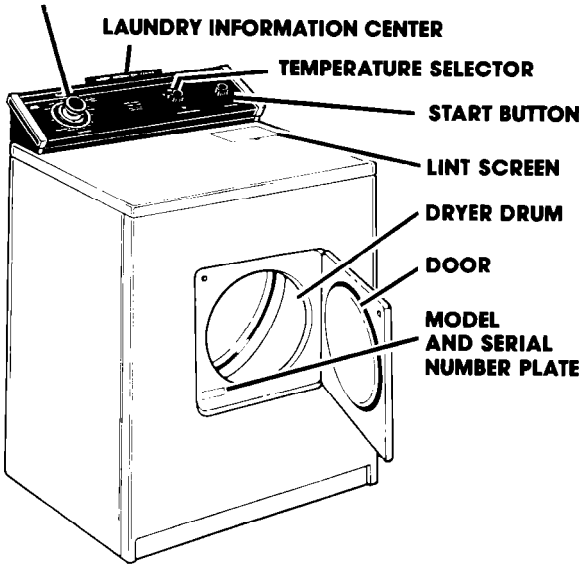

Remove the Consumer Buy Guide label before using your dryer. It will be easier to remove.

Wipe out the dryer drum with a damp cloth to remove dust from storing or shipping.

Copy your Model and Serial Numbers here

When you need service or call with a question, have this information ready:

- 1. Complete** Model and Serial Numbers (from the plate located as shown).
- Purchase date from sales slip.

Copy this information in these spaces. Keep this book in the Laundry Information Center with your "Dryer Guide," sales slip and warranty.

Please complete and mail the Owner Registration Card furnished with this product.

Model Number

Serial Number

Purchase Date

Service Company
Telephone Number

Contents

	Page		Page
PARTS AND FEATURES	2	Drying Times	8
IMPORTANT SAFETY		Mixed Loads	8
INSTRUCTIONS	3	Lint Signal	8
OPERATING INSTRUCTIONS	4	LINT SCREEN	9
Selecting a Cycle and		LINT REMOVAL	9
Starting Your Dryer	4	CARING FOR YOUR DRYER	10
Automatic Cycles	6	Cleaning Dryer Interior	10
Timed Drying	6	Vacation Care	10
DRYING TIPS	7	IF YOU NEED SERVICE OR	
FLUFF AIR Setting	7	ASSISTANCE	11
TUMBLE PRESS® Setting	7	WHIRLPOOL DRYER	
Automatic DRY-MISER®		WARRANTY	12
Control	7		

Important safety instructions



WARNING: To reduce the risk of fire, electric shock, or injury to persons when using your dryer, follow basic precautions, including the following:

Read these laundry instructions carefully for important use and safety information before using your dryer.

NEVER dry items cleaned, washed, soaked in or spotted with wax, paint, gasoline, or flammable fluids in the dryer. The fumes can create a **FIRE HAZARD** or **EXPLOSION**. **ALWAYS** hand launder and air dry fabrics containing these materials.

NEVER allow children to operate, play with, or crawl inside the dryer. Close supervision of children is necessary when the dryer is used near children.

When discarding an old dryer, **ALWAYS** remove the door to prevent accidental entrapment.

DO NOT reach into a dryer if the drum is moving.

DO NOT install or store dryer where it will be exposed to the weather.

DO NOT tamper with the controls.

Dryer must be electrically grounded. See the "Installation Instructions."

You are personally responsible for making sure that your dryer is installed, repaired and parts replaced by a qualified person.

Use only fabric softeners specifically labeled as not being harmful to the dryer. **FIRE HAZARD** and **DAMAGE** to materials can result from:

- drying rubber, rubber-like and heat sensitive materials with heat.
- allowing lint build-up inside the dryer or exhaust system – cleaning should be done periodically by a qualified person.

Clean lint screen before or after each load.

DO NOT let dust, lint, paper, rags, chemicals, etc. pile up around or under the dryer.

• **SAVE THESE INSTRUCTIONS** •

Additional Safety Instructions and Your Responsibilities

NEVER operate the dryer if...

- it is not working right (i.e. noisy, too hot).
- it is damaged.
- parts are missing (i.e. door latch).
- all panels are not in place.
- the lint screen is loose, damaged or missing.

FOR YOUR SAFETY

If you smell gas:

1. Open windows.
2. Don't touch electrical switches.
3. Extinguish any open flame.
4. Immediately call your gas supplier.

FOR YOUR SAFETY

Do not store or use gasoline or other flammable vapors and liquids in the vicinity of this or any other appliance.

ALWAYS shut off the gas valve before leaving on vacation.

ALWAYS unplug the power supply cord or turn off electrical power before attempting to service the dryer. Shut off **GAS VALVE** if yours is a gas dryer.

You are personally responsible for making sure that your dryer...

- is properly maintained.
- is properly installed and leveled in a well ventilated room* on a floor that can support the weight.
- is located in an area where the temperature is above 45°F (7.2°C).
- is connected to the proper outlet and electrical supply.*
- is properly connected to fuel and exhaust systems.*
- is not installed against drapes or curtains.*
- is used only for jobs normally expected of home clothes dryers.
- is not used by children or anyone unable to operate it properly.

*See "Installation Instructions" for complete information.

Operating instructions

Selecting a Cycle and Starting Your Dryer

Before starting your dryer, be sure laundry is sorted and loaded properly (see your "Dryer Guide"). **Be sure the door is tightly closed.**

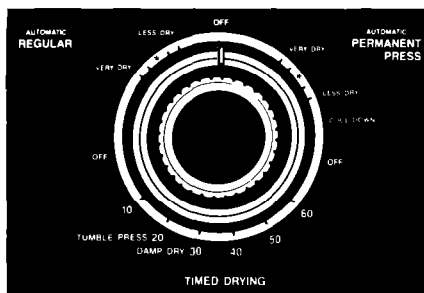

TYPE OF LOAD	SUGGESTED CYCLE	SUGGESTED TEMPERATURE
COTTONS – LINENS		
EXTRA HEAVY – Bedspreads, mattress pads, quilts	AUTOMATIC REGULAR	PERM'T PRESS HEAVY HIGH
HEAVYWEIGHT FABRICS – Towels, jeans, corduroys, work clothes		
MEDIUMWEIGHT COTTONS – Sheets, pillowcases, cotton underwear, diapers		
LIGHTWEIGHT COTTONS – Batistes, organdies, lingerie		
PERMANENT PRESS, SYNTHETICS AND BLENDS		
HEAVYWEIGHT FABRICS – Work clothes, jackets, raincoats	AUTOMATIC PERMANENT PRESS	PERM'T PRESS HEAVY HIGH
MEDIUMWEIGHT FABRICS – Shirts, play clothes, sheets, slacks		
LIGHTWEIGHT FABRICS – Lingerie, blouses, dresses		
KNITS		
HEAVYWEIGHT – Cottons, rayons, blends, T-shirts, slacks, shirts	AUTOMATIC PERMANENT PRESS	PERM'T PRESS HEAVY HIGH KNITS GENTLE LOW
LIGHTWEIGHT – Synthetics (polyester, acrylic, etc.) and blends, lingerie, blouses, dresses		
LIGHTWEIGHT AND DELICATE FABRICS		
Sheer Curtains (2 or 3 panels)	AUTOMATIC PERMANENT PRESS	KNITS GENTLE LOW
Gauze, lace, etc.		
RUBBER, PLASTIC, HEAT-SENSITIVE FABRICS		
FOAM RUBBER – Pillows, bras, stuffed toys	20-30 MINS.	FLUFF AIR
PLASTIC – Shower curtains, tablecloths	20-30 MINS.	
RUBBER-BACKED RUGS	40-50 MINS.	
OLEFIN, POLYPROPYLENE, SHEER NYLON ...	15-20 MINS.	



WARNING: Drying these and other heat-sensitive materials with heat can damage them or be a FIRE HAZARD.

LARGE CAPACITY
5 CYCLE 3 TEMP
AUTOMATIC DRY WASH
ENERGY EFFICIENT



TEMPERATURE SELECTOR



PUSH TO START

1. Select a CYCLE

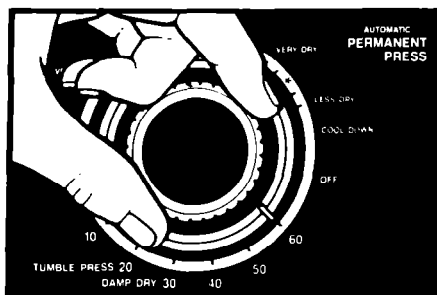

Turn the Control Knob either way to point to the cycle and setting you want. See page 6 for information on the cycles.

2. Set TEMPERATURE SELECTOR

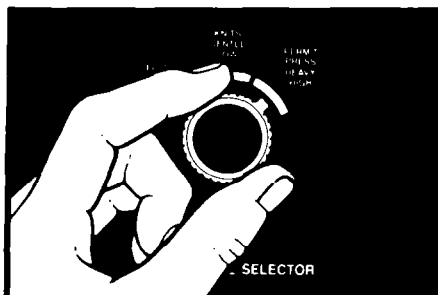

Turn the Temperature Selector to the needed drying temperature

3. Push the START Button

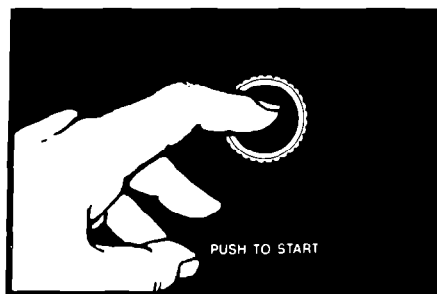

The dryer will start tumbling when you push the START Button.

To stop and restart the dryer

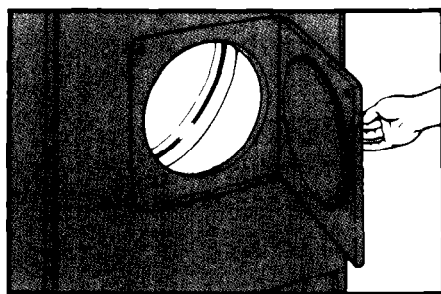

To stop the dryer, open the door (or turn the Control Knob to OFF).

To restart the dryer, close the door, select cycle, if necessary, and push START.

The Cycle Control Knob should point to an OFF area when the dryer is not in use. If the dryer is stopped before the cycle is finished, turn the Cycle Control Knob to an OFF area.

The automatic cycles

The automatic cycles allow you to select the degree of dryness you prefer for the clothes being dried.

The Control Knob will not move until the clothes load is almost dry, or the COOL-DOWN portion of the cycle has been reached. After COOL-DOWN, the knob automatically moves to an OFF area and tumbling stops.

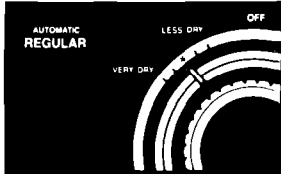

Use **AUTOMATIC REGULAR** to dry heavy and medium-

weight cotton items. **The load tumbles without heat during the last 5 minutes.** This helps make the load easier to handle.

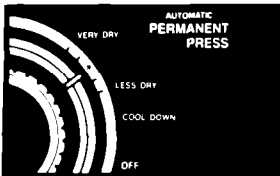

Use **AUTOMATIC PERMANENT PRESS** to dry permanent

press, knits and other synthetic fabrics. **The load tumbles without heat during the last 10 minutes.** This helps keep wrinkles from setting in, and makes the load easier to handle.

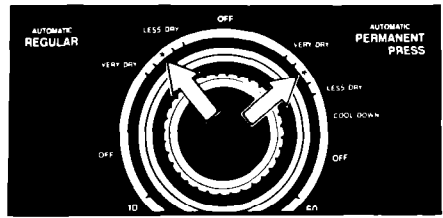

For the first few loads, set the Control Knob to point to an * in either automatic cycle. When the dryer stops, feel the dried items.

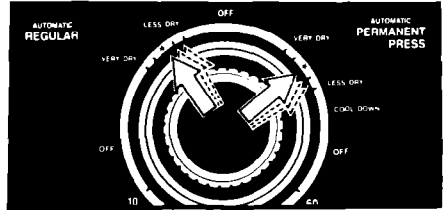

- If items are drier than you like, use a setting to the right of the * the next time you dry a similar load.

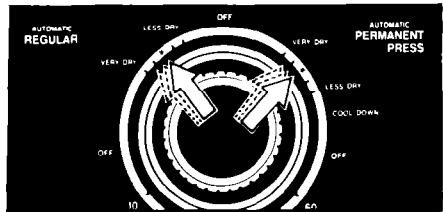

- If items are not as dry as you like, use a setting to the left of the * the next time you dry a similar load.

OVERDRYING CAN CAUSE SHRINKAGE, STATIC CLING AND DAMAGE TO SOME FABRICS.

Timed drying

Use the TIMED DRYING Cycle for any load you want to dry by time. For example: small loads, large bulky items, items to be fluffed or dusted with the FLUFF AIR heat setting.

- Turn the Control Knob to the number of minutes you want – from 10 to 60.
- The last 5 minutes of this cycle are without heat – a cool-down time. This helps make the load easier to handle.

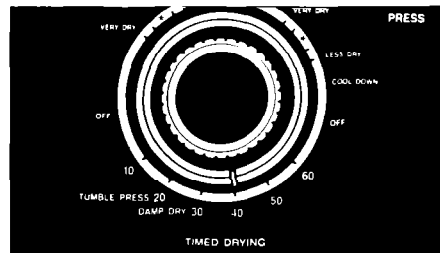

Drying tips

FLUFF AIR

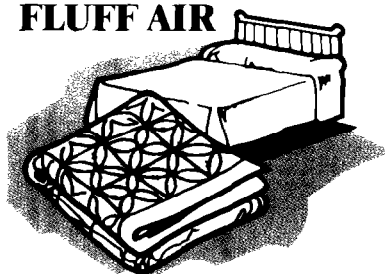

The dryer does not heat when the Temperature Selector is set on FLUFF AIR. This setting can be used to fluff bedding, plastic tablecloths, foam rubber pillows, stuffed toys, sneakers, etc.

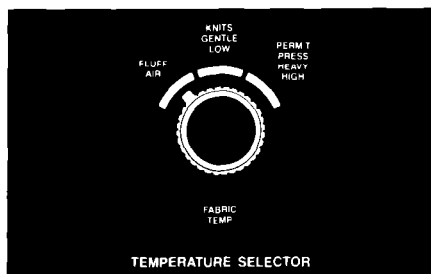

1. Turn the Temperature Selector to FLUFF AIR.
2. Turn the Control Knob to the number of minutes you want in the TIMED DRYING Cycle.
3. Push the START Button.



WARNING: Drying plastic or rubber items with heat may damage the items or be a FIRE HAZARD.

Automatic DRY-MISER® Control

The thermostat senses the air temperature. The dryer automatically shuts off when the selected dryness is reached.

TUMBLE PRESS® Setting

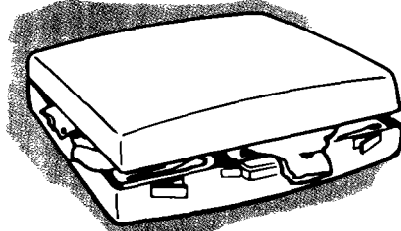

The TUMBLE PRESS setting removes wrinkles from dry clothing such as items that may have been packed in a suitcase, closet, or items not removed from the dryer.

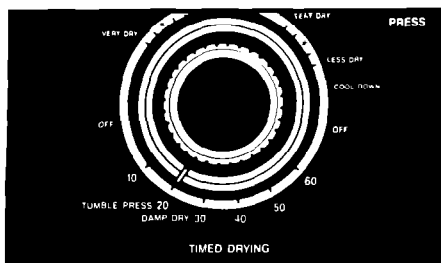

1. Turn Control Knob to TUMBLE PRESS.
2. Turn Temperature Selector to PERM'T PRESS HEAVY HIGH.
3. Push START Button.

The load will tumble in heated air for 15 minutes. The heat shuts off and the dryer continues to tumble the load for 5 more minutes.

For best results, TUMBLE PRESS only a few items at a time. Put them on hangers or fold them as soon as the dryer stops.

Drying times

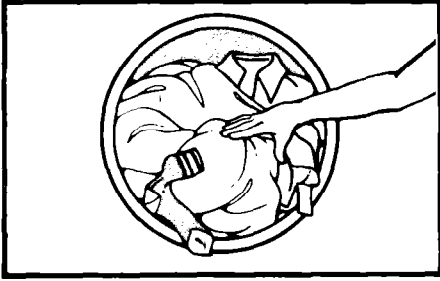

Drying times will vary depending on:

- amount of moisture in the clothes.
- type and weight of the fabric.
- size of the load.
- room temperature around the dryer.
- temperature of the wash rinse water.
- amount of lint in the lint screen.
- dryer temperature selection.

See your "Dryer Guide" for more information.

Mixed loads

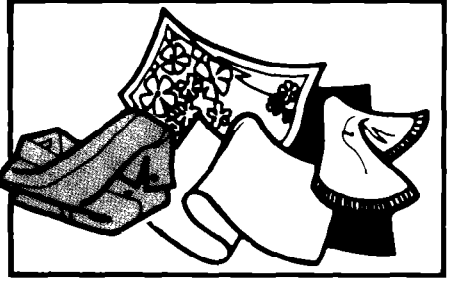

When drying a load with different kinds and weights of fabrics, use the cycle suggested for the lightest fabrics. When the dryer stops, remove dry items and reset the control.

To reduce wrinkling, take the load from dryer as soon as tumbling stops. This is important for permanent press, knits and synthetic fabrics.

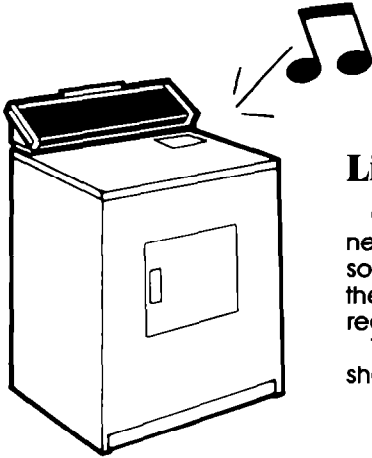

Lint signal

Clean lint screen **before each load**. If you neglect to clean your lint screen, the signal will sound. The (whistle tone) signal lets you know the air flow is being restricted. Restricted air flow reduces drying efficiency.

Turn off the dryer and clean the lint screen as shown on page 9.

Lint screen

Clean the lint screen before each load. A screen blocked by lint can increase drying time and may be a FIRE HAZARD.

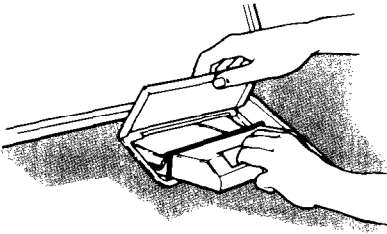

Open the lid and pull the lint screen straight out.

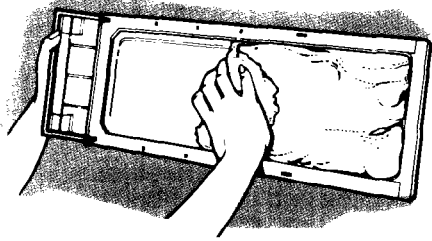

ROLL the lint off the screen with your fingers.

DO NOT rinse or wash the screen. Push the screen firmly back into place.



WARNING: DO NOT run the dryer with the lint screen loose, damaged, blocked or missing. Doing so can cause overheating, damage fabrics and be a **FIRE HAZARD**.

Lint removal

Lint can gather inside the dryer and create a **FIRE HAZARD**. This lint should be removed at least every 2 to 3 years, or more often, depending on dryer usage.

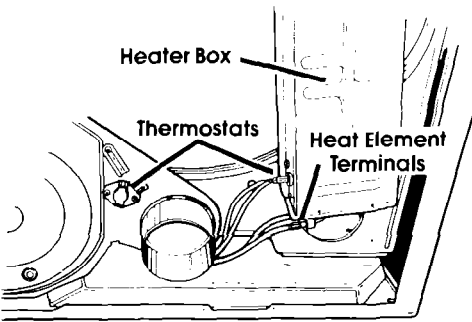

ELECTRIC DRYERS

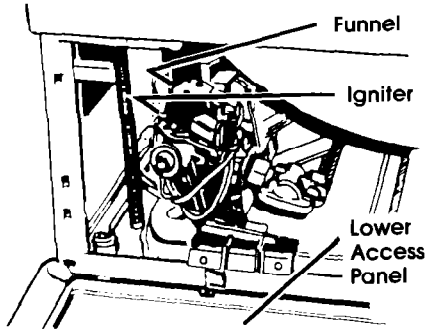

GAS DRYERS

Cleaning should be done only by a qualified person.



WARNING:

- Avoid electrical shock hazard – unplug power supply cord or turn off electrical power.
- Avoid injury or damage – do not put hands inside cabinet.
- Make sure dryer is cool.

1. Remove back panel (electric) or lower access panel (gas).
2. Avoid damaging wires, thermostats, funnel or igniter.
3. Remove lint from shaded area – see art – with a soft brush or vacuum cleaner.
4. Replace panel; reconnect and re-level dryer.

Caring for your dryer



Remove loose and sharp objects from pockets and cuffs before drying – pins, buckles, etc. **Close metal zippers.**

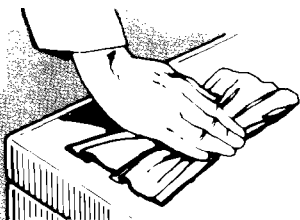

Wipe off all spills with a damp, soft cloth. Spills allowed to remain may dull or damage the finish.

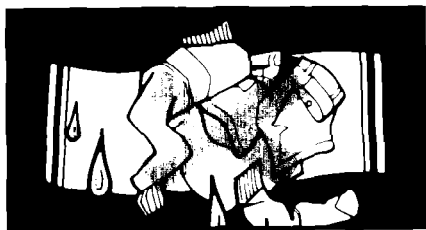

Never leave wet or damp laundry in your dryer.

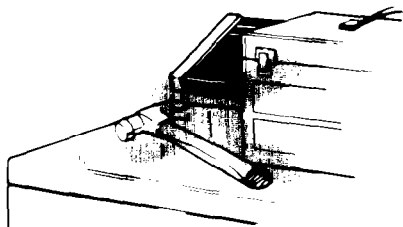

Sharp or heavy objects should never be put on or in the dryer. Check pockets for bolts, nuts etc.

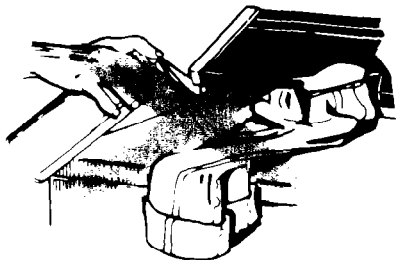

Some pretreatment products can damage dials, consoles and finish. Do not use these products on or near your dryer.

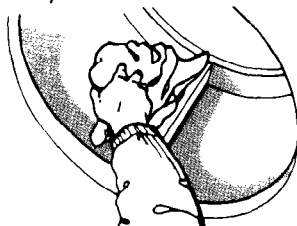

Cleaning dryer interior



WARNING: Before cleaning interior, unplug power supply cord or, turn off electrical power to avoid electrical shock hazard.

dyes, such as denim blue jeans or brightly colored cotton items, may discolor the dryer interior. If the interior is discolored, clean with one of the following methods to avoid staining later load items.

Powdered laundry detergent and very warm water

Make a paste with detergent and very warm water. Apply paste to a soft cloth and scrub area until all excess dye is removed. Wipe thoroughly with a damp cloth. Tumble a load of rags. –OR–

Liquid spray household cleaner

Spray on stained area. Rub with a cloth until all excess dye is removed. Tumble a load of rags.

Vacation care

- Unplug power cord or turn off electrical power.
- For gas dryers, close gas valve.
- Clean lint screen.

If you need service or assistance, we suggest you follow these five steps:

1. Before calling for assistance...

Performance problems often result from little things you can find and fix yourself without tools of any kind.

IF YOUR DRYER DOES NOT RUN:

- Is the power supply plugged into a live circuit with the proper voltage?
- Is the door closed tightly?
- Did you push the START Button?
- Have you checked your home's main fuses or circuit breaker box?

IF YOUR DRYER DOES NOT HEAT:

- The AIR setting is without heat.
- The last minutes of heat settings are without heat.
- Is the gas turned on? If not, turn the Control Knob to OFF. Turn on gas. Wait 5 minutes. Reset controls and start.
- An electric dryer uses a circuit breaker or 2 fuses. If one fuse is blown, the dryer may run, but not heat.

IF DRYING TIME SEEMS TOO LONG:

- Is the lint screen clean? See page 9 of this book for cleaning instructions.
- See page 8 of this book and your "Dryer Guide."

2. If you need assistance*...

Call Whirlpool COOL-LINE® service assistance telephone number. Dial free from anywhere in the U.S.:

1-800-253-1301

and talk with one of our trained Consultants. The Consultant can instruct you in how to obtain satisfactory operation from your appliance or, if service is necessary, recommend a qualified service company in your area.

3. If you need service*...



Whirlpool has a nationwide network of franchised TECH-CARE® Service Companies. TECH-CARE service

technicians are trained to fulfill the prod-

uct warranty and provide after-warranty service, anywhere in the United States. To locate TECH-CARE service in your area, call our COOL-LINE service assistance telephone number (see Step 2) or look in your telephone directory Yellow Pages under:

<p>APPLIANCES - HOUSEHOLD - MAJOR - SERVICE & REPAIR</p> <p>WHIRLPOOL APPLIANCES FRANCHISED TECH-CARE SERVICE</p> <p><i>SERVICE COMPANIES</i></p> <p>XYZ SERVICE CO 123 MAPLE</p>	<p>OR</p>	<p>ELECTRICAL APPLIANCES - MAJOR - REPAIRING & PARTS</p> <p>WHIRLPOOL APPLIANCES FRANCHISED TECH-CARE SERVICE</p> <p><i>SERVICE COMPANIES</i></p> <p>XYZ SERVICE CO 123 MAPLE</p>
<p>OR</p>		
<p>WASHING MACHINES, DRYERS & IRONERS - SERVICING</p> <p>WHIRLPOOL APPLIANCES FRANCHISED TECH-CARE SERVICE</p> <p><i>SERVICE COMPANIES</i></p> <p>XYZ SERVICE CO 123 MAPLE</p>		

4. If you have a problem*...

Call our COOL-LINE service assistance telephone number (see Step 2) and talk with one of our Consultants, or if you prefer, write to:

Mr. Robert Stanley
Division Vice President
Whirlpool Corporation
2000 M-63
Benton Harbor, MI 49022

5. If you need FSP® replacement parts*...

FSP is a registered trademark of Whirlpool Corporation for quality parts. Look for this symbol of quality whenever you need a replacement part for your Whirlpool appliance. FSP replacement parts will fit right and work right, because they are made to the same exacting specifications used to build every new Whirlpool appliance.

*If you must call or write, please provide: model number, serial number, date of purchase, and a complete description of the problem. This information is needed in order to better respond to your request for assistance.

WHIRLPOOL[®] DRYER WARRANTY

DR001

LENGTH OF WARRANTY	WHIRLPOOL WILL PAY FOR
FULL ONE-YEAR WARRANTY From Date of Purchase	FSP* replacement parts and repair labor to correct defects in materials or workmanship. Service must be provided by a franchised TECH-CARE [®] service company.
WHIRLPOOL WILL NOT PAY FOR	
A. Service calls to: <ol style="list-style-type: none">1. Correct the installation of the dryer.2. Instruct you how to use the dryer.3. Replace house fuses or correct house wiring or plumbing.4. Replace light bulbs. B. Repairs when dryer is used in other than normal, single-family household use. C. Pick up and delivery. This product is designed to be repaired in the home. D. Damage to dryer caused by accident, misuse, fire, flood, acts of God or use of products not approved by Whirlpool.	

WHIRLPOOL CORPORATION SHALL NOT BE LIABLE FOR INCIDENTAL OR CONSEQUENTIAL DAMAGES. Some states do not allow the exclusion or limitation of incidental or consequential damages so this limitation or exclusion may not apply to you. This warranty gives you specific legal rights, and you may also have other rights which vary from state to state.

Outside the United States, a different warranty may apply. For details, please contact your franchised Whirlpool distributor or military exchange.



Part No. 3388787 Rev. A
©1987 Whirlpool Corporation

Printed in U.S.A.

Automatic Washers, Clothes Dryers, Freezers, Refrigerator-Freezers, Ice Makers, Dishwashers, Built-In Ovens and Surface Units, Range

